



NIMMI 

NEUVO BOX



NIMMI APP



NUDR- Neuvo Synchronised Drawer Runner

NEUVORUNNER



Features

- Next Generation synchronised runner system
- Can be installed on drawers with side panel up to 19mm
- Compliant to system 32
- Tested for 50,000 cycles
- Load capacity 40Kg



Length(mm)	300, 350, 400, 450, 500
------------	-------------------------

Side Panel Installation Positions

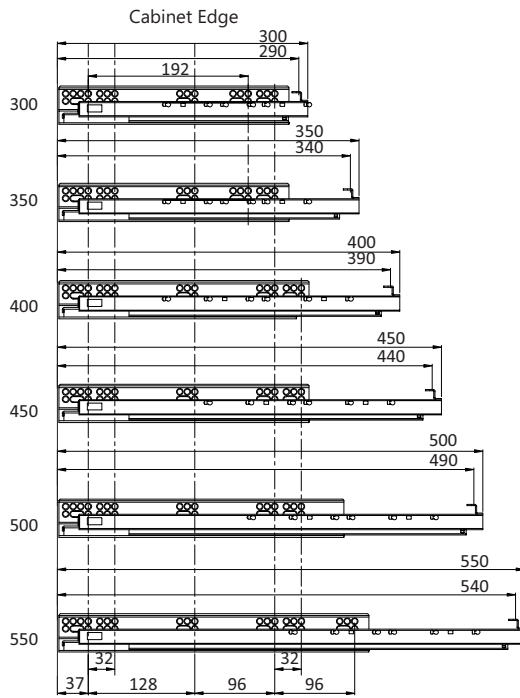

Installation for drawer with max. 19mm side

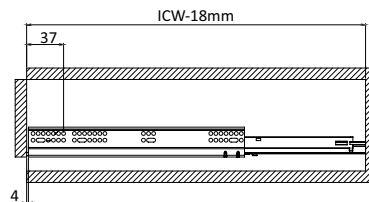
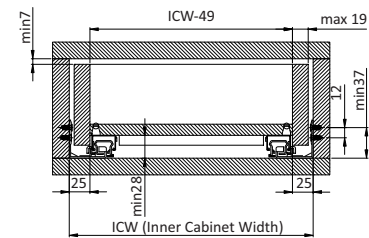

Features

- Next generation drawer system employing fully synchronized runners
- Load capacity 40Kg
- Thin side profile of just 13mm
- No need to buy rear connectors or gallery rails separately
- Fully compliant to system 32
- Tested for 50,000 cycles

Low



Medium

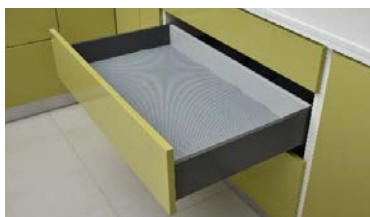

High



Finish

Grey



White



Stainless Steel



Glass Side - High

Grey



White



Side Panel Installation Positions

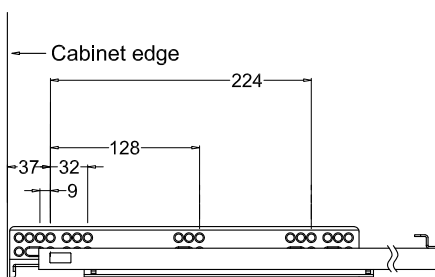

NL 400/450/500

Draw Front

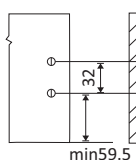

ICW : Inner Cabinet Width
OW : Outer Width

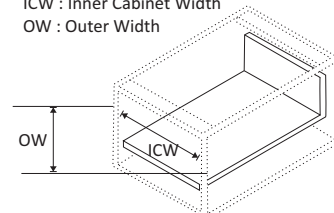

Min. Internal cabinet Depth = Min.ICD=NL+3

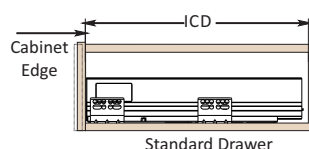

Bottom and Back Panel Preparation

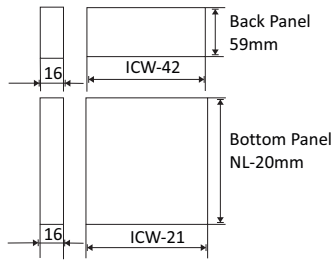

Space requirement in cabinet

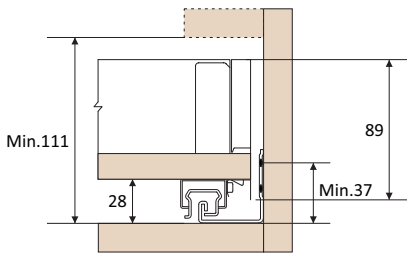

NEUVOBOX - Low

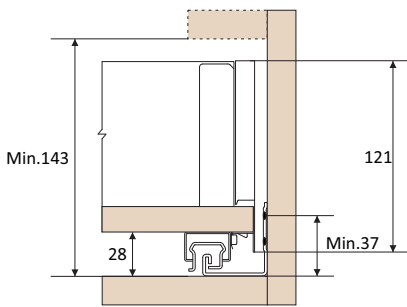

NEUVOBOX - Medium

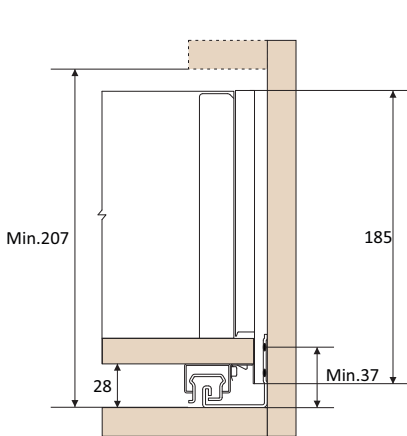

NEUVOBOX - High

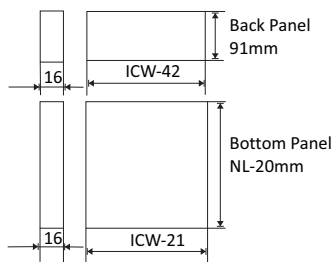

Installation Dimensions for Front Connector

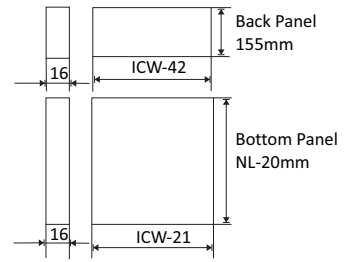
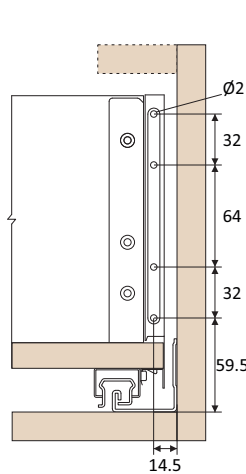
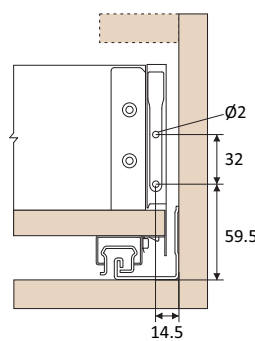
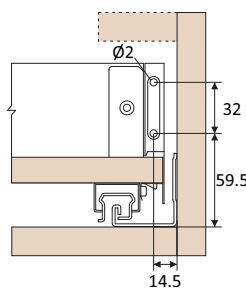

Installation Dimensions for Rear Connector

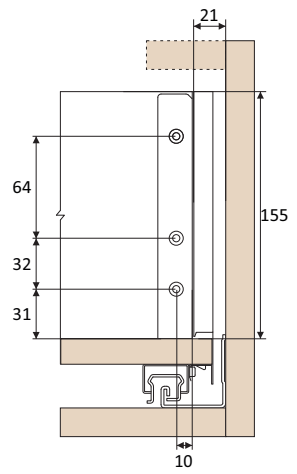
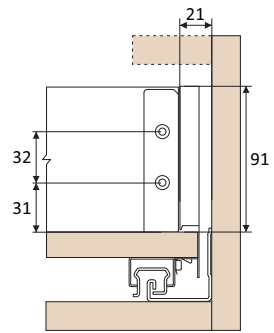
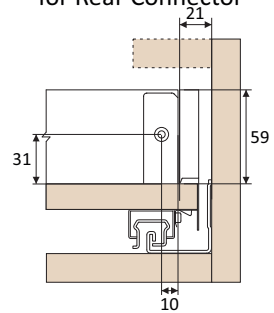

NBDSACC001 - Section 1100mm Cut to Any Size



- Used as cross rail for high classic inner drawer
- Can be used as a cross organising rail for NBDS drawers (OR)
- Can be used as a cross rail for NBDS

Item Code	Size(mm)	Finish
NBDSACC001	1100	Grey White

NBDSACC002 - Cross Rail Side Connector



- Used as side connector for NSDSACC001

Item Code	Finish
NBDSACC002	Grey White

NBDSACC004 - Cross Centre Connector



- To be used to connect cross rails

Item Code	Finish
NBDSACC004	Grey

NBDSACC005 - Divider

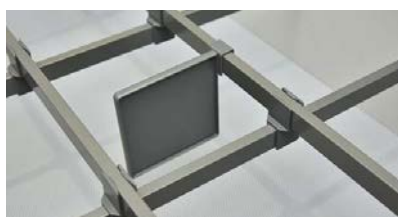

- Organiser for NBDS drawers to be used with NBDSACC001

Item Code	Finish
NBDSACC005	Grey White

NBDSACC006 - Cover Cap for NBDSACC001



- Cover cap for vertical organising profile in NBDS drawer.

Item Code	Finish
NBDSACC006	Grey White



NIBDS1 - Classic Inner Draw Connector



- Inner draw connector for draws with aluminium front

Length	Finish
Low Medium High	Grey White

NIBDS2 - Niche Inner Draw Connector (Glass)



- Inner draw connector for draws with glass front

Length	Finish
Low Medium High	Grey White

NIBDS1FS - Front Section 1100mm Classic



- Front section classic inner drawer
- Same section for all heights

Item Code	Size(mm)	Finish
NIBDS1FS	1100	Grey White

NIBDS2FS - Front Section 1100mm Niche (Glass)



- Front section niche inner drawer (Glass)
- Same section for all heights

Item Code	Size(mm)	Finish
NIBDS2FS	1100	Grey White

